

**3.6kW/6kW
OFF GRID SOLAR INVERTER**

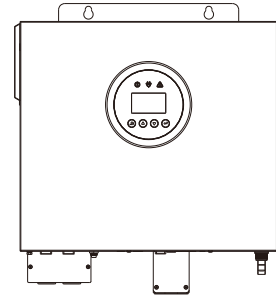

User Manual

Copyright Statement

The copyright of the Manual is owned by the manufacturer.
Please keep the Manual properly and strictly follow all safety and operating instructions in the Manual. Do not operate the inverter before reading the Manual.

CONTENTS

1	Safety Introduction	01
1.1	Proper Manual Keeping	01
1.2	Requirements for Operators	01
1.3	Warning Signs	01
1.4	Setting of Safety Warning Signs	02
1.5	Measuring Equipment	02
1.6	Moisture Prevention	02
1.7	Precautions	02
2	Introduction	04
3	Characteristics	05
4	System Infrastructure	06
5	Product Overview	07
6	Installation	08
6.1	Unpacking and Inspection	08
6.2	Installation Preparation	09
6.3	Battery Connection	09
6.4	AC Input/Output Connection	11
6.5	PV Connection	13
6.6	Communication Connection	15
7	Operation	17
7.1	Power On/Off	17
7.2	Operation and Display Panel	18
7.3	Function Description	18
7.4	Display	19
7.5	Settings	25
8	Wireless Router Operation Guide	33
8.1	App Download	33
8.2	Installation of Collector	33

8.3	Collector Status	34
8.4	Handling of Abnormal Conditions	34
8.5	Operation Method of the Reset Button	36
9	SOLARMAN Smart APP	37
9.1	Registration	37
9.2	Create a Plant	37
9.3	Add a Collector	38
9.4	Network Configuration	38
10	Alarm and Fault Codes	41
10.1	Alarm Codes	41
10.2	Fault Codes	42
11	Fault Diagnosis and Handling	44
11.1	Fault Diagnosis Table	44
12	Product Specifications	48
13	Routine Maintenance	50
13.1	Inspection Plan for Cables, Equipment and Terminals	50
13.2	Equipment Cleaning	50
13.3	Cleaning and Maintenance of Dust Protection Kit	50
14	Quality Commitment	52
15	Limitation of Liability	53

1 Safety Introduction

1.1 Proper Manual Keeping

The Manual contains vital information regarding equipment operation. Please read it carefully before operation and strictly follow the instructions in the Manual to prevent potential damage or loss to the equipment, personnel, and property. Keep this manual properly for maintenance and repair purposes.

1.2 Requirements for Operators

Operators are required to possess professional qualifications or undergo training. They must be familiar with the entire system, including the composition and operating principles of the equipment. Operators are expected to be acquainted with the product instructions. Maintenance personnel must not operate any equipment until all equipment is turned off and powered down.

1.3 Warning Signs

Warning signs contain crucial safety operation information and must not be torn or damaged. Ensure warning signs are always correctly and securely placed, and damaged signs must be promptly replaced.



This sign indicates a dangerous situation that, if not avoided, could pose a threat to personal safety!



This sign signifies the presence of high voltage danger and risk of electric shock.



To prevent electric shock or personal injury, refrain from touching or using the inverter until 5 minutes have lapsed since its shutdown or disconnection.



This sign warns of hot surfaces and the risk of burns!



Refer to the operation instructions.

1.4 Setting of Safety Warning Signs

During guidance, maintenance, and repair processes, please follow the instructions below to prevent misuse by non-professionals or accidents:

- Prominent signs shall be placed at the front and rear switches to prevent accidents caused by incorrect switching.
- Warning signs or caution lines shall be arranged near the operating area.
- The system must be reinstalled after maintenance or operation.

1.5 Measuring Equipment

To ensure that electrical parameters match the requirements, relevant measuring equipment is needed during system connection or testing. Ensure that the specifications of the equipment being connected and used are compatible to prevent electric arc or shock.

1.6 Moisture Prevention

Moisture can potentially damage the inverter; therefore, repairs or maintenance shall be avoided in humid weather conditions.

1.7 Precautions

- 1.7.1 During operation and maintenance, comply with relevant safety standards and regulation. Disconnect all electrical connections to prevent equipment from being powered on. After disconnection, wait at least 5 minutes for the residual voltage in the capacitors to drop to a safe level and use a multimeter to ensure complete discharge of the equipment.
- 1.7.2 Repairs of the equipment can only be carried out by professionals, and it is strictly prohibited to open the equipment modules without permission. Proper protective measures shall be taken during maintenance, such as using insulated gloves, insulated shoes, and noise-proof earplugs.
- 1.7.3 In order to reduce application risks, lead-acid batteries with deep-cycle charging and discharging must be used. Using other types of lead-acid batteries may result in battery damage and shorten battery life.
- 1.7.4 NEVER charge a frozen battery.
- 1.7.5 In case of deep discharge, if the entire inverter is in a static state (i.e. the battery has not been charged for two weeks or longer), the battery must be recharged to a state of charge between 30% and 50%.
- 1.7.6 For each input wire, choose the correct wire diameter according to specifications to avoid the risks of electric shock or fire.
- 1.7.7 Do not short-circuit AC input or output and DC input.

- 1.7.8 During installation or maintenance, take care to prevent tools from falling, which could lead to battery short circuits.
- 1.7.9 Adopt PV junction boxes with surge protection. Otherwise, damage to the inverter may occur when the PV modules are struck by lightning.
- 1.7.10 Due to the non-isolated nature of this inverter, only three types of PV modules (monocrystalline silicon modules, grade A polysilicon modules, and CIGS modules) are acceptable. To avoid any faults, do not connect any PV modules with possible current leakage to the inverter. Otherwise, an additional isolation output device is required. For example, grounding PV modules will lead leakage current to the inverter. If using CIGS modules, ensure there is no grounding connection.
- 1.7.11 For configurations without PV switches, mains switches, or battery switches, an additional AC or DC switch that meets the maximum current requirements needs to be added to ensure personal safety.
- 1.7.12 Contact the nearest hazardous waste disposal station when the products or components are discarded.

The Manual serves as a guide and reference for installation and operation. If there are any issues or situations not covered in the Manual, please contact us without delay.

2 Introduction

This is a multifunctional integrated inverter that combines the functions of an inverter, solar charger, and battery charger, ensuring uninterrupted power supply. The LCD display screen provides users with a configurable and user-friendly interface, allowing for setting of battery charging current, priority between mains charging and solar charging, priority between mains power supply and solar power supply, battery EOD shutdown point, generator connection enabling, backlight time, regular dust removal reminders, etc. The screen can display voltage, current, and power for each port on separate pages, and also record machine faults, power generation and other information. This inverter is equipped with optional communication interfaces including the USB, RS232, RS485, dry contact, WIFI module, and parallel module, catering to the demand for more intelligent management.

3 Characteristics

- With advanced topology architecture, the battery inverter efficiency can reach up to 93.5%.
- PV and AC charging current is up to 120A
- Pure sine wave inverter
- 2.4-inch dot matrix screen
- External Wi-Fi for monitoring (APP required)
- Communication ports reserved for BMS (RS485, CAN)
- Configurable input voltage range for household appliances and personal computers via LCD control panel
- Configurable power supply priority via LCD control panel
- Configurable battery charging current and charging priority based on application via LCD control panel
- Compatible with generators
- Built-in PV terminal for easy installation

4 System Infrastructure

The diagram below illustrates the basic application of the device, requiring the following equipment to have a complete operating system:

- Generator or utility power
- PV modules

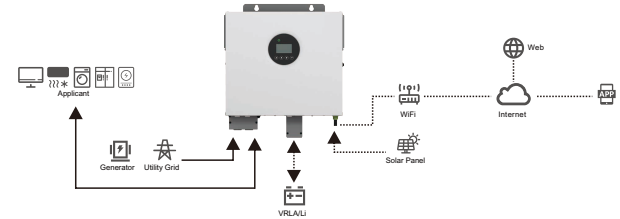

Consult your system integrator to explore other potential system architectures based on your requirements.

This inverter can power various appliances in household or office settings, including motor-operated appliances like downlights, fans, refrigerators, and air conditioners.

The schematic diagram of system wiring is as follows:

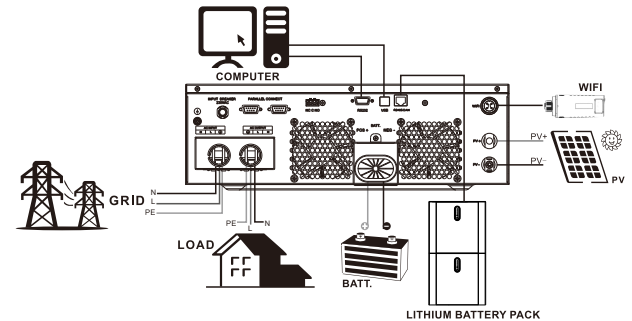

5 Product Overview

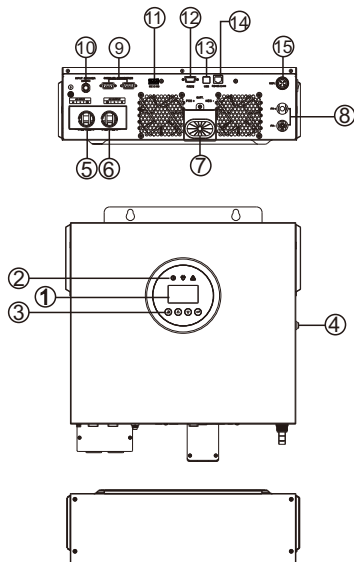

- | | |
|-------------------------|-----------------------------------|
| 1. LCD | 9. Parallel connectors (optional) |
| 2. LED | 10. Circuit breaker |
| 3. Function keys | 11. Dry contact |
| 4. Power on/off switch | 12. RS232 |
| 5. AC input connectors | 13. USB |
| 6. AC output connectors | 14. RS485/CAN (optional) |
| 7. Battery connectors | 15. WIFI (optional) |
| 8. PV connectors | |

6 Installation

The Manual outlines the basic steps for installing and setting up the inverter.









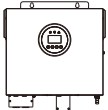

CAUTION:

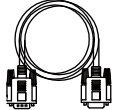
Be careful when unpacking to prevent damage to the components.

6.1 Unpacking and Inspection

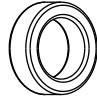
Before installation, please inspect the equipment to ensure there is no damage to the packaging. Your package should include the following items, and please confirm their integrity.

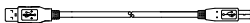
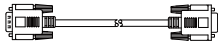
 1 x Inverter Unit	 1 x User Manual	 1 x RS-232 cable
 2 x Dust-proof pad	 1 x PV external wiring terminal	 1 x Battery fuse
 1 x Battery terminal magnetic ring	 2 x Cable tie	 1 x WiFi module data collector (optional accessory)
 1 x USB cable (optional accessory)		 1 x Parallel cable Db9 (optional accessory)

6.2 Installation Preparation

Open the junction box and connect the input and output cables.

Before select the installation position, please consider the following:

- Please avoid installing the inverter on flammable building materials.
- Install the inverter on a solid surface.
- Install the inverter at eye level for easy viewing of the readings displayed by LCD.
- To ensure air circulation and heat dissipation, please leave approximately 30cm of space on the left and right sides of the unit and approximately 50cm of space above and below the unit.
- The inverter will be installed in the room to avoid direct sunlight, rain, humidity, wind and rain erosion.
- The ambient temperature shall be between -10°C and 50°C to ensure optimum operation.
- It is recommended to install the inverter vertically on a wall.
- Please ensure that other objects and surfaces are arranged as shown in the diagram to ensure adequate heat dissipation and wiring space.

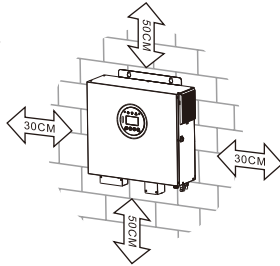

Tighten the two screws to install the device. M5 or M6 screws are recommended.

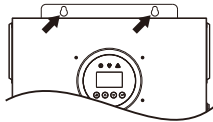

6.3 Battery Connection

Note! To ensure safe operation and compliance, a separate DC overcurrent protector or disconnecting device between the battery and inverter is required. In some applications, installing circuit breakers may not be essential, but overcurrent protection devices are still recommended. Please refer to typical amps as required.

Warning! All connections must be made by qualified personnel.

Warning! The positive and negative poles of the battery cannot be reversed.

Warning! Using proper cables to connect the battery is crucial for safe and efficient operation of the system. To reduce the risk of injury, please adopt the recommended cable and terminal sizes provided below.

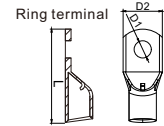

Wire Specifications for Standard Configuration of 3.6K-6K Split Unit							
Model	Current at battery terminal/A	Cross-sectional area of the wire	Wiring requirements	Ring terminal Dimensions			Torque Value
				D1	D2	L	
3600-24	167A	70mm ²	2*1AWG	8.5mm	21mm	49mm	5Nm
3600-48	83A	25mm ²	2AWG	8.5mm	21mm	45.5mm	
6000-48	139A	50mm ²	0AWG/2*2AWG	8.5mm	21mm	49mm/ 45.5mm	

Steps for battery connections:

- (1) The 3600-24 model supports 24VDC systems, the 3600-48 model supports 48VDC systems, and the 6000-48 model supports 48VDC systems. Connect all battery packs according to the following diagram. For the 3.6KW model, it is recommended to connect batteries with a capacity of at least 100Ah. For the 6KW model, it is recommended to connect batteries with a capacity of at least 200Ah.

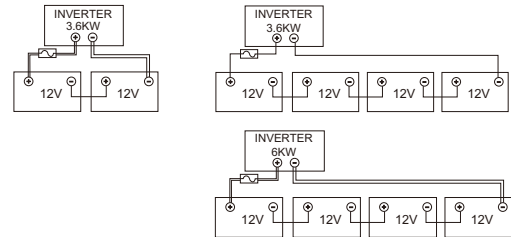

- (2) Based on cable sizes, prepare two battery wires for the 3600-24 model, one battery wires for the 3600-48 model, and one or two battery wires for the 6000-48 model (please refer to the recommended cable size table). Attach ring terminals to your battery wires and secure them to the battery terminal board using properly tightened bolts. For the torque values, please refer to the battery cable size. Ensure correct polarity connection between the battery and the inverter, with the ring terminals securely fastened to the battery terminals.

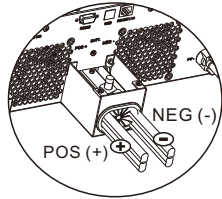

3600-24 (using 2*1AWG battery wires)
 3600-48 (using 2AWG battery wires)
 6000-48 (using 0AWG/2*2AWG battery wires)

Note: The battery connection cables depicted on the diagram indicate the quantity of use for either POS (+) or NEG (-) ends.

Warning: Danger of Electric Shock
 Due to the high voltage of batteries connected in series, caution must be exercised during installation.

Caution! ! Do not place anything on the flat part of the inverter terminal or between the ring terminals. Otherwise, overheating may occur. **Caution!** ! Do not apply antioxidant to the terminals until the terminals are securely connected.
Caution! ! Before making the final DC connection or closing the DC circuit breaker/disconnector, ensure that the positive terminal (+) must be connected to the positive terminal (+), and the negative terminal (-) must be connected to the negative terminal (-).

6.4 AC Input/Output Connection

Caution! ! Before connecting to the AC input power supply, install a separate AC circuit breaker between the inverter and the AC input power supply. This will ensure that the inverter can be safely disconnected during maintenance and receive comprehensive protection against AC input overcurrent. The recommended specifications for the AC circuit breaker are 32A for 3.6KW and 50A for 6KW.

Caution! ! There are two terminal boards marked "IN" and "OUT." Do not incorrectly connect the input and output connectors.

Warning! All connections must be made by qualified personnel.

Warning! Using appropriate cables to connect the AC input is crucial for the safe and efficient operation of the system. To reduce the risk of injury, please adopt the cable sizes as recommended below.

Recommended Cable Requirements for AC Wires

Wire Specifications for Standard Configuration of 3.6K-6K Split Unit			
Model	3600-24	3600-48	6000-48
AC input current/A	15.7	15.7	26
Cross-sectional area of the wire	3mm ²	3mm ²	5mm ²
Wire diameter	12AWG	12AWG	10AWG
AC output current/A	15.7	15.7	26
Cross-sectional area of the wire	3mm ²	3mm ²	5mm ²
Wire diameter	12AWG	12AWG	10AWG
Torque Value	1.2Nm		

Steps to implement AC input/output connection:

- (1) Before performing AC input/output connection, make sure to turn on the DC protector or disconnecter.
- (2) Open the terminal wiring cover, and remove six screw terminals.
- (3) Insert the AC input wires according to the polarity indicated on the terminal board and tighten the terminal screws. Always connect the PE protective conductor first (⊕)

⊕ → Earth wire (yellow-green)
 L → Live wire (brown or black)
 N → Neutral wire (blue)

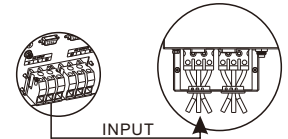

Warning: Before the AC power supply is hard-wired to the equipment, ensure that the AC power supply is disconnected.

- (4) Next, insert the AC output wires according to the polarity indicated on the terminal board and tighten the terminal screws. Be sure to connect the PE protective conductor (⊕)

⊕ → Earth wire (yellow-green)
 L → Live wire (brown or black)
 N → Neutral wire (blue)

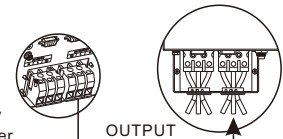

- (5) Make sure the wires are securely connected and lock the terminal cover.

CAUTION: Appliances such as air conditioner requires at least 2-3 minutes to restart because it's required to have enough time to balance refrigerant gas inside of circuits. If a power shortage occurs and recovers in a short time, it will cause damage to your connected appliances. To prevent this kind of damage, please check if the air conditioner manufacturer has provided a time-delay function before installation. Otherwise, this inverter/charger will trigger an overload fault and cut off output to protect your appliance, but sometimes it still causes internal damage to the air conditioner.

6.5 PV Connection

Warning! Before connecting the PV modules, install a separate DC circuit breaker between the inverter and the PV modules.

Warning! Using appropriate cables to connect the PV modules is crucial for the safe and efficient operation of the system. To reduce the risk of injury, please adopt the cable sizes as recommended below.

Wire Specifications for Standard Configuration of 3.6K-6K Split Unit			
Model	PV current	Wire diameter	Cross-sectional area of the wire
3600-24	18A	12AWG	3mm ²
3600-48	18A	12AWG	3mm ²
6000-48	22A	12AWG	3mm ²

Note: Due to the non-isolated nature of this inverter, only three types of PV modules (monocrystalline silicon modules, grade A polysilicon modules, and CIGS modules) are acceptable. To avoid any faults, do not connect any PV modules with possible current leakage to the inverter. Otherwise, an additional isolation output device is required. For example, grounding PV modules will lead leakage current to the inverter. If using CIGS modules, ensure there is no grounding connection.

Note: Adopt PV junction boxes with surge protection. Otherwise, damage to the inverter may occur when the PV modules are struck by lightning.

6.5.1 Selection of PV Modules

Consider the following parameters when selecting suitable PV modules:

The open-circuit voltage (Voc) of the PV module must not exceed the maximum PV array open-circuit voltage of the inverter. The open-circuit voltage (Voc) of the PV module shall be higher than the startup voltage.

INVERTER MODEL	3600-24	3600-48	6000-48
Max. PV Array Power	3600W	3600W	6000W
Max. PV Array Open Circuit Voltage	500V		
PV Array MPPT Voltage Range	120Vdc-450Vdc		
Start-up Voltage	120Vdc		

Take the 250Wp PV module as an example. Considering the two parameters mentioned above, the recommended module configuration is as shown in the table below.

Solar Panel Spec. (reference)	SOLAR INPUT	Q'ty of panels	Total input power
	Min in series: 6 pcs, max. in series: 12pcs.		
-250Wp			
-Vmp: 30.1Vdc	6 pcs in series	6pcs	1500W
-Imp: 8.3A	8 pcs in series	8pcs	2000W
-Voc: 37.7Vdc	12 pcs in series	12pcs	3000W
-Isc: 8.4A	8pieces in series and 2 sets in parallel	16pcs	4000W
-Cells: 60	10 pieces in series and 2 sets in parallel (only for 6KVA model)	20pcs	5000W
	11 pieces in series and 2 sets in parallel(only for 6KVA model)	22pcs	5500W
	12 pieces in series and 2 sets in parallel(only for 6KVA model)	24pcs	6000W

6.5.2 Wire Connection of PV Modules

Please take the following measures to connect the PV modules:

1. Connect the PV wiring terminals to the corresponding PV positive (+) and PV negative (-) terminals on the machine.

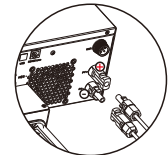

6.6 Communication Connection

Connect all communication lines according to the following diagram.

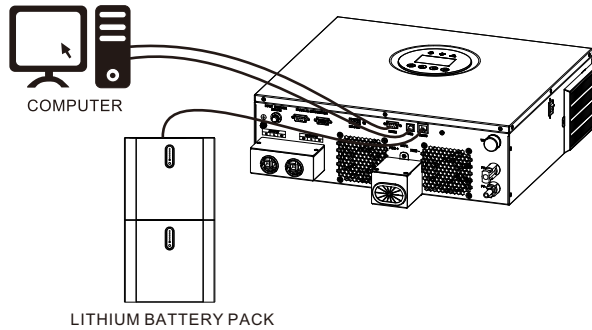

6.6.1 Serial Port Connection

Use the supplied serial cable to connect the inverter to your computer. Please refer to the attached user manual for instruction.

6.6.2 Wi-Fi Connection (optional)

This equipment is equipped with a Wi-Fi transmitter. The Wi-Fi transmitter enables wireless communication between the off-grid inverter and the monitoring platform. Users can access and control monitored inverters through APP. You can find the "SOLARMAN Smart" APP in the Apple Store or in the Google Play Store. All data loggers and parameters are stored in iCloud. For quick installation and operation, please refer to "8. Wireless Router Operation Guide" for detailed information.

6.6.3 BMS Communication Connection (optional)

If connected to a lithium-ion battery pack, you'll need to use a dedicated communication cable and follow the protocol of the matching inverter manufacturer.

6.6.4 Dry Contact

There is one dry contact (3A/250VAC) available on the rear panel. It could be used to deliver signal to external device when battery voltage reaches warning level.

Unit Status	Condition		Dry contact port:		
			NC C NO	NC & C NO & C	
Power Off	Unit is off and no output is powered.		Close	Open	
Power On	Output is powered from Battery power or Solar energy.	Setting option 2 detailed in 7.5 Settings: set as USB (utility first) or SUB (solar first).	Battery voltage < Low DC warning voltage	Open	Close
			Battery voltage > Setting value (Setting option 13 detailed in 7.5 Settings) or battery charging reaches floating stage	Close	Open
	Setting option 2 detailed in 7.5 Settings: set as SBU (SBU priority)	Battery voltage < Setting value (Setting option 12 detailed in 7.5 Settings)	Open	Close	
		Battery voltage > Setting value (Setting option 13 detailed in 7.5 Settings) or battery charging reaches floating stage	Close	Open	

6.6.5 Parallel Communication (optional)

It is possible to set up 2 to 6 units for parallel operation, with the maximum capacity for 6 units to operate in parallel.

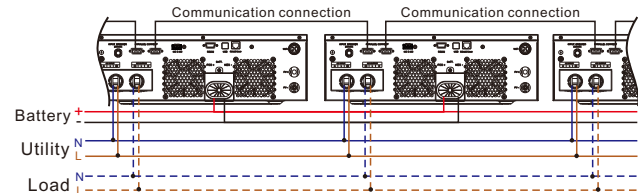
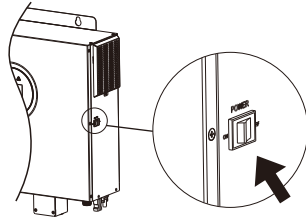

Diagram illustrating the connection of 2-6 parallel power cables and communication cables.

7 Operation

7.1 Power On/Off

Once the device is correctly installed and the battery is well connected, simply press the on/off switch (located on the side of the inverter) to turn on the device. When the device is powered on for the first time and you enter the startup interface, select the battery type, and set the battery capacity, mode priority, clock, etc.



Startup Interface Information Input Diagram:

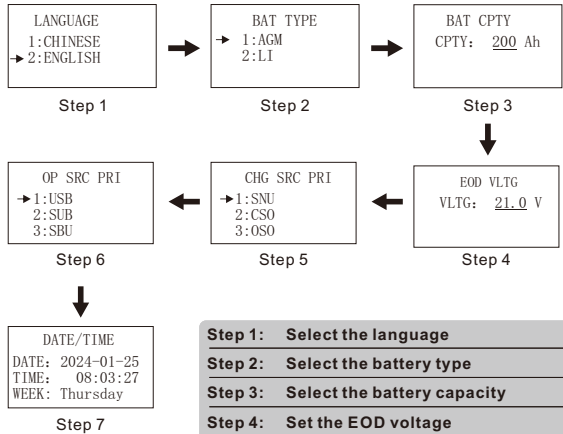

- Step 1: Select the language**
- Step 2: Select the battery type**
- Step 3: Select the battery capacity**
- Step 4: Set the EOD voltage**
- Step 5: Set the priority of charging source**
- Step 6: Set the priority of output source**
- Step 7: Set the time information**

7.2 Operation and Display Panel

The LCD operation panel shown in the diagram below consists of four touch-sensitive function keys, an LCD display, and LED lights, which is used to indicate operation status and input/output power information.

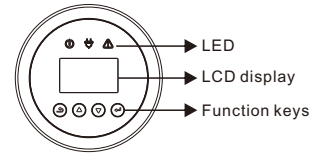

7.3 Function Description

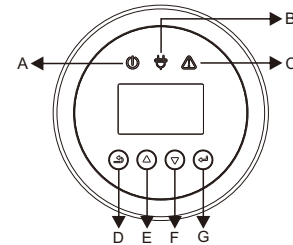

Knight II 3.6K-6K EMS Panel

Object	Name	Description
A	LED indicator light	Green: Grid connection status
B		Green: Off-grid status
C		Red: Inverter fault status
D	Key functions	Return key: (1) Exit current interface or function. (2) Enter the setting interface.
E		Up key: Move the cursor up or increase the value.
F		Down key: Move the cursor down or decrease the value.
G		Enter key: Confirm the selection.

7.4 Display

7.4.1 Main Interface Display

GRID DATA VOLG: 0.0V CUR: 0.0A FREQ: 0.0Hz	Power grid port display interface	OUTPUT VOLG: 229.2V CUR: 9.3A FREQ: 50.0Hz	Output display interface
PV INPUT VOLG: 299.3V CUR: 13.3A FOWER: 4020W	PV display interface	BATTERY VOLG: 54.4V CUR: -28.3A SOC: 81.0%	Battery display interface
POWER INFO INV: 2250W GRID: 0W PV: 4022W	Power display interface	POWER INFO BAT: -1534W LOAD (W): 2135W LOAD (VA): 2144VA	Power display interface
POWER INFO LOAD (%): 34%	Power display interface	FIRMWARE VER ARM: V000B000D000 DSP: V000B000D000	Firmware display interface
TEMPERATURE AMBTEMP: 26℃	Temperature display interface	ALARM FAULT ALARM: W00-1 FAULT: F00-1	Fault display interface
MACHING MODEL 6000-48	Maching model interface		

7.4.2 Set menu interface

Interface	Description
-----------	-------------

SETUP → 1:AC IP RANGE 2:OUTPUT 3:OP SRC PRI 4.BAT 5.FUNTION 6.ENERGY 7. BASIC SET	1. Setting interface of AC input range 2.Output 3. Setting interface of output source priority 4.Battery 5.Funtion 6.Energy 7.Basic setting
--	---

7.4.2.1 AC input range setting interface

Interface	Description
AC IP RANGE → 1:APL 2:UPS	Setting interface of AC input range

7.4.2.2 Output interface setting

Interface	Description
OUTPUT → 1:OUTPUT VLTG 2:OUTPUT FREQ	Setting interface of output voltage and output frequency
(1) OUTPUT VLTG OUTPUT VLTG → 1:220V 2:230V 3.240V	Setting interface of output voltage
(2) OUTPUT FREQ OUTPUT FREQ → 1:50Hz 2:60Hz	Setting interface of output frequency

7.4.2.3 Output source priority setting interface

Interface	Description
OP SRC PRI → 1:USB 2:SUB 3:SBU	Setting interface of output source priority
(1) SBU SBU → 1:SBU CHG 2:SBU DSCHG	Setting interface of SBU charging voltage and SBU discharging voltage

(1_1) SBU CHG

SBU CHG
VLTG: 23.0 V

Setting interface of SBU charging voltage

(1_2) SBU DSCHG

SBU DSCHG
VLTG: 27.0 V

Setting interface of SBU discharging voltage

(4_1) MAX CHG

MAX CHG
CURRENT: 30 A

Setting interface of maximum charging current

(4_2) MAX AC CHG

MAX AC CHG
CURRENT: 30 A

Setting interface of maximum AC charging current

7.4.2.4 Battery settings interface

Interface	Description
<p>BAT</p> <p>→ 1: BAT TYPE</p> <p>2: BAT CPTY</p> <p>3: CHG VLTG</p> <p>4: CHG CUR</p> <p>5: CHG SRC PRI</p>	<p>1. Battery type</p> <p>2. Battery capacity</p> <p>3. Charging voltage</p> <p>4. Charging current</p> <p>5. Setting interface of charging source priority</p>

(1) BAT TYPE

BAT TYPE
→ 1: AGM

2: LI

Setting interface of battery type

(2) BAT CPTY

BAT CPTY
CPTY: 200 Ah

Setting interface of battery capacity

(3) CHG VLTG

CHG VLTG
→ 1: CONST CHG

2: FLOAT CHG

3: EOD VLTG

1. Constant charging

2. Float charging

3. EOD voltage

(3_1) CONST CHG

CONST CHG
VLTG: 28.2 Ah

Setting interface of constant charging voltage

(3_2) FLOAT CHG

FLOAT CHG
VLTG: 27.0 V

Setting interface of float charging voltage

(3_3) EOD VLTG

EOD VLTG
VLTG: 21.0 V

Setting interface of EOD voltage

(4) CHG CUR

CHG CUR
→ 1: MAX CHG

2: MAX AC CHG

Setting interface of charging current

(5) CHG SRC PRI

CHG SRC PRI
→ 1: SNU

2: CSO

3: OSO

Setting interface of charging source priority

7.4.2.5 Function interface settings

Interface	Description
<p>FUNTION</p> <p>→ 1: O/T RESRT</p> <p>2: BUZZER</p> <p>3: GENERATOR</p> <p>4. PRISRC ALM</p> <p>5. BYPASS O/L</p> <p>6. NO-LOAD S/D</p> <p>7. OUTPUT MODE</p> <p>8. BAT LOSS ALM</p> <p>9. PV ISO</p>	<p>1. Overtemperature restart</p> <p>2. Buzzer</p> <p>3. Generator</p> <p>4. Primary source alarm</p> <p>5. Bypass overload</p> <p>6. Idle shutdown</p> <p>7. Output mode</p> <p>8. Battery loss alarm</p> <p>9. PV ISO</p>
<p>(1) O/T RESRT</p> <p>O/T RESRT → 1: DISABLE</p> <p>2: ENABLE</p>	<p>Setting interface of overtemperature restart enabling</p>
<p>(2) BUZZER</p> <p>BUZZER → 1: DISABLE</p> <p>2: ENABLE</p>	<p>Setting interface of buzzer</p>
<p>(3) GENERATOR</p> <p>GENERATOR → 1: DISABLE</p> <p>2: ENABLE</p>	<p>Setting interface of generator</p>
<p>(4) PRISRC ALM</p> <p>PRISRC ALM → 1: DISABLE</p> <p>2: ENABLE</p>	<p>Setting interface of primary source alarm</p>
<p>(5) BYPASS O/L</p> <p>BYPASS O/L → 1: DISABLE</p> <p>2: ENABLE</p>	<p>Setting interface of bypass overload</p>
<p>(6) NO-LOAD S/D</p> <p>NO-LOAD S/D → 1: DISABLE</p> <p>2: ENABLE</p>	<p>Setting interface of idle shutdown</p>
<p>(7) OUTPUT MODE</p> <p>OUTPUT MODE → 1: SINGLE</p> <p>2: PARALLEL</p>	<p>Setting interface of output mode</p>

(7_1) PAR

PAR → 1: PAR ADDR 2: PAR TTL NUM 3: PAR RED NUM	1.Parallel address 2.Parallel redundancy number 3. Idle shutdown	PAR ADDR ID: 1	Setting interface of parallel address
--	--	-------------------	---------------------------------------

(7_2) PAR TTL NUM

PAR TTL NUM NUM: 2	Setting interface of parallel number	PAR RED NUM REDUM: 0	Setting interface of parallel redundancy number
-----------------------	--------------------------------------	-------------------------	---

(7_3) PAR RED NUM

(8) BAT LOSS ALM

BAT LOSS ALM → 1: DISABLE 2: ENABLE	Setting interface of battery loss alarm	PV ISO → 1: DISABLE 2: ENABLE	Setting interface of PV ISO
---	---	-------------------------------------	-----------------------------

(9) PV ISO

7.4.2.6 Electricity interface settings

Interface	Description
ENERGY → 1: E-TODAY 2: E-MONTH 3: E-YEAR 4: E-TOTAL 5: E-CLEAR	1. Electricity for today 2. Electricity for the month 3. Electricity for the year 4. Total electricity 5. Clear power record

(1) E-TODAY

E-TODAY PV: 1.0KWH LOAD: 1.0KWH	Electricity for today	E-MONTH PV: 2KWH LOAD: 2KWH	Electricity for the month
---------------------------------------	-----------------------	-----------------------------------	---------------------------

(2) E-MONTH

(3) E-YEAR

E-YEAR PV: 2KWH LOAD: 2KWH	Electricity for the year	E-TOTAL PV: 2KWH LOAD: 2KWH	Total electricity
----------------------------------	--------------------------	-----------------------------------	-------------------

(4) E-TOTAL

(5) E-CLEAR

E-CLEAR → 1: CANCEL 2: CONFIRM	Clear power record interface
--------------------------------------	------------------------------

7.4.2.7 Basic settings interface

Interface	Description		
BASIC SET 1: LANGUAGE → 2: DATE/TIME 3: LIGHT TIME 4: RECORD 5: CLEAR RCRD 6: CLEAR DUST 7: FCTY RESET	1. Language setting interface 2. Date/time 3. Backlight time 4. Record interface 5. Clear record 6. Clear dust 7. Factory reset		
LANGUAGE 1: CHINESE → 2: ENGLISH	Language setting interface	DATE/TIME DATE: 2020-11-24 TIME: 05:47:59 WEEK: Tuesday	Setting interface of date/time
LIGHT TIME INPUT: 20 UNIT: SEC	Setting interface of backlight time	REC (274) 1: F04-1 DATE: 2020-11-24 TIME: 05:16:49	Record interface
CLEAR RCRD → 1: CANCEL 2: CONFIRM	Clear record interface	CLEAR DUST TIME → 1: THREE MONTHS 2: SIX MONTHS	Clear dust time interface
CLEAR DUST → 1: DISABLE 2: ENABLE	Clear dust interface	FCTY RESET → 1: CANCEL 2: CONFIRM	Setting interface of factory reset

7.5 Settings

7.5.1 Return Key "↩"

Pressing the return key on the main display interface allows entry into the settings menu interface. Pressing the return key on the settings menu interface allows returning to the main display interface. Pressing the return key on the setting item interface allows returning to the settings menu interface.

7.5.2 Up Key "▲"

Pressing the up key enables page scrolling upwards.

7.5.3 Down Key "▼"

Pressing the down key enables page scrolling downwards.

7.5.4 Enter Key "↵"

Pressing the enter key on the settings menu interface allows entry into the setting item interface pointed by the arrow. Pressing the enter key on the main display interface has no effect.

(1) Language setting

Interface	Description
LANGUAGE 1: CHINESE → 2: ENGLISH	ENGLISH (default); choose between Chinese or English

(2) Output source priority setting

Interface	Description
OP SRC PRI → 1: USB 2: SUB 3: SBU	<p>USB (default): Utility will provide power to the loads as first priority. Solar and battery energy will provide power to the loads only when utility power is not available.</p> <p>SUB : Solar energy provides power to the loads as first priority. If solar energy is not sufficient to power all connected loads, Utility energy will supply power to the loads at the same time.</p> <p>SBU : Solar energy provides power to the loads as first priority. If solar energy is not sufficient to power all connected loads, battery energy will supply power to the loads at the same time.</p>

(3) Setting interface of charging source priority

Interface	Description
CHG SRC PRI → 1: SNU 2: CSO 3: OSO	<p>SNU (default): Solar energy and utility will charge battery at the same time.</p> <p>CSO : Solar energy will charge battery as first priority. Utility will charge battery only when solar energy is not available.</p> <p>OSO : Solar energy will be the only charger source no matter utility is available or not.</p>

(4) Setting interface of AC input range

Interface	Description
AC IP RANGE → 1: APL 2: UPS	<p>APL (default): If selected, acceptable AC input voltage range will be within 90-280VAC.</p> <p>UPS : If selected, acceptable AC input voltage range will be within 170-280VAC.</p>

(5) Setting interface of AC input range

Interface	Description
OUTPUT MODE → 1: SINGLE 2: PARALLEL	You can select either Single (default) or Parallel mode. Single indicates independent mode, while Parallel indicates parallel mode.

(6) Output voltage setting

Interface	Description
OUTPUT VLTG 1: 220V → 2: 230V 3: 240V	The default output voltage is 230V, with the option to choose different output voltages ranging from 220V, 230V, 240V.

(7) Output frequency setting

Interface	Description
OUTPUT FREQ → 1: 50Hz 2: 60Hz	The default output frequency is 50Hz, with the option to select either 50Hz or 60Hz.

(8) Maximum charging current setting

Interface	Description
<div style="border: 1px solid black; padding: 5px; width: fit-content;"> MAX CHG CURRENT: <u>30</u> A </div>	For the 3600-24 model and 6000-48 model, the default charging current is 30A, with the ability to set the current from 10A to 120A. For the 3600-48 model, the default charging current is 10A, with the option to adjust the current from 10A to 60A. The increment per click is 10A.

(9) Maximum AC charging current setting

Interface	Description
<div style="border: 1px solid black; padding: 5px; width: fit-content;"> MAX AC CHG Current: <u>30</u> A </div>	For the 3600-24 model and 6000-48 model, the default charging current is 30A, with the ability to set the current from 10A to 120A. For the 3600-48 model, the default charging current is 10A, with the option to adjust the current from 10A to 60A. The increment per click is 10A.

(10) Maximum AC charging current setting

Interface	Description
<div style="border: 1px solid black; padding: 5px; width: fit-content;"> BAT TYPE → 1:AGM 2:LI </div>	AGM (default) represents lead-acid batteries, Li represents lithium batteries. Two types of AGM or Li can be set.

(11) Overtemperature restart enabling setting

Interface	Description
<div style="border: 1px solid black; padding: 5px; width: fit-content;"> O/T RESRT → 1:DISABLE 2:ENABLE </div>	DISABLE (default); you can choose between DISABLE and ENABLE. If ENABLE is chosen, the machine can automatically restart at high temperatures.

(12) SBU charging voltage setting

Interface	Description
<div style="border: 1px solid black; padding: 5px; width: fit-content;"> SBU CHG VLTG: <u>23.0</u> V </div>	SBU charging voltage can be set. For the 3600-24 model, the default voltage is 23V and the setting range is 22.0-25.5V; for the 3600-48 model and 6000-48 model, the default voltage is 46V and the setting range is 44.0V-51.0V.

(13) SBU discharging voltage setting

Interface	Description
<div style="border: 1px solid black; padding: 5px; width: fit-content;"> SBU DSCHG VLTG: <u>27.0</u> V </div>	SBU discharging voltage can be set. For the 3600-24 model, the default voltage is 27V and the setting range is 24-29V; for the 3600-48 model and 6000-48 model, the default voltage is 54V and the setting range is 48V-58V.

(14) Constant charging voltage setting

Interface	Description
<div style="border: 1px solid black; padding: 5px; width: fit-content;"> CONST CHG VLTG: <u>28.2</u> V </div>	For the 3600-24 model, the default constant charging voltage is 28.2V; for the 3600-48model and 6000-48 model, the default constant charging voltage is 56.4V.

(15) Float charging voltage setting

Interface	Description
<div style="border: 1px solid black; padding: 5px; width: fit-content;"> FLOAT CHG VLTG: <u>27.0</u> V </div>	For the 3600-24 model, the default float charging voltage is 27V; for the 3600-48 model and 6000-48 model, the default float charging voltage is 54V.

(16) EOD voltage setting

Interface	Description
<div style="border: 1px solid black; padding: 5px; width: fit-content;"> EOD VLTG VLTG: <u>21.0</u> V </div>	The EOD voltage can be set. For the 3600-24model, the default voltage is 21V and the setting range is 21V-24V; for the 3600-48 model and 6000-48 model, the default voltage is 42V and the setting range is 42V-48V.

(17) Buzzer setting

Interface	Description
BUZZER 1:DISABLE → 2:ENABLE	ENABLE (default); you can choose between DISABLE and ENABLE.

(18) Record interface

Interface	Description
REC (274) 1:F04-1 DATE: 2020-11-24 TIME: 05:16:49	Record current alarm and fault displays, along with time information.

(19) Battery capacity setting

Interface	Description
BAT CPTY CPTY: 200 Ah	The battery capacity is 200Ah (default), adjustable based on different battery types, with a range from 100Ah to 10000Ah.

(20) Back light time setting

Interface	Description
LIGHT TIME INPUT: 20 UNIT: SEC	Adjustable backlight time, default at 20S, with a range from 20S to 120S.

(21) Date/time setting

Interface	Description
DATE/TIME DATE: 2020-11-24 TIME: 05:47:59 WEEK: Tuesday	Time information can be set.

(22) SBU charging voltage setting

Interface	Description
GENERATOR → 1:DISABLE 2:ENABLE	Compatible generator (DISABLE by default), which can be set to DISABLE or ENABLE.

(23) Clear record setting

Interface	Description
CLEAR RCRD → 1:CANCEL 2:CONFIRM	Able to clear record information, with two options for selection - CANCEL (default) or CONFIRM.

(24) Factory reset

Interface	Description
FCTY RESET → 1:CANCEL 2:CONFIRM	Factory reset is available, with two options for selection - CANCEL (default) or CONFIRM.

(25) Primary source alarm setting

Interface	Description
PRISRC ALM → 1:DISABLE 2:ENABLE	Able to set primary source alarms, with two options for selection - DISABLE or ENABLE (default).

(26) Bypass overload setting

Interface	Description
BYPASS O/L → 1:DISABLE 2:ENABLE	Able to set bypass overload, with two options for selection - DISABLE (default) or ENABLE. When enabled, the unit will transfer to line mode if overload occurs in battery mode.

(27) Parallel address setting

Interface	Description
PAR ADDR ID: 1	Able to set parallel address, with the default ID as 1.

(28) Parallel number setting

Interface	Description
PAR TTL NUM NUM: 2	Able to set up 2 to 6 units for parallel operation, with the maximum capacity for 6 units to operate in parallel (default number : 2).

(29) Parallel redundancy number setting

Interface	Description
PAR RED NUM REDUM: 0	Able to set parallel redundancy number, with the default number being 0.

(30) Parallel redundancy number setting

Interface	Description
IDLE SD → 1:DISABLE 2:ENABLE	Able to set the idle shutdown function, with two options for selection - DISABLE (default) or ENABLE. When ENABLE is chosen, the machine will shut down after running continuously with idle or small load for 30 minutes.

(31) Clear power record interface

Interface	Description
CLR P RCRD → 1:CANCEL 2:CONFIRM	Able to clear the power record, with two options for selection - CANCEL (default) or CONFIRM.

(32) Electricity for today

Interface	Description
E-TODAY PV: 1.0KWH LOAD: 1.0KWH	PV represents the daily PV power generation. LOAD represents the daily power consumption of the load.

(33) Electricity for the month

Interface	Description
E-MONTH PV: 2KWH LOAD: 2KWH	PV represents the monthly PV power generation. LOAD represents the monthly power consumption of the load.

(34) Electricity for the year

Interface	Description
E-YEAR PV: 2KWH LOAD: 2KWH	PV represents the yearly PV power generation. LOAD represents the yearly power consumption of the load.

(35) Total electricity

Interface	Description
E-TOTAL PV: 2KWH LOAD: 2KWH	PV represents the total PV power generation. LOAD represents the total power consumption of the load.

(36) Clear dust

Interface	Description
CLEAR DUST → 1:DISABLE 2:ENABLE	ENABLE (default). Users can choose between DISABLE and ENABLE. When users select ENABLE, they can choose the scheduled dust removal time.

(37) Battery loss alarm

Interface	Description
BAT LOSS ALM → 1:DISABLE 2:ENABLE	ENABLE (default), the user can choose between DISABLE and ENABLE. When the user selects ENABLE, the machine will display an alarm when there is no battery.

(38) PV ISO

Interface	Description
PV ISO → 1:DISABLE 2:ENABLE	DISABLE(default), the user can choose between DISABLE and ENABLE. When the user selects ENABLE while the PV insulation resistance detection is abnormal, the machine will report a fault and turn off the output.

8 Wireless Router Operation Guide

8.1 App Download

Step: Scan the QR code to download the APP.

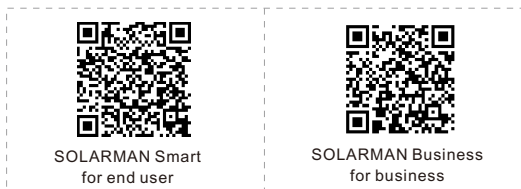

For iPhone: Search for "SOLARMAN Smart" in Apple Store.
For Android: Search for "SOLARMAN Smart" in Google Play.

8.2 Installation of Collector

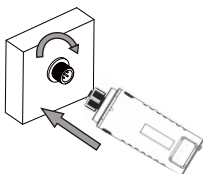

Step: Install the collector to the communication interface of the inverter as shown in the figure.

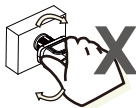

CAUTION
Do not rotate the collector when installing and removing it.



8.3 Collector Status

Indicator	Description	Status description (All indicators are single green)
	Communication with router	Light Off: unable to connect to the router. 1s On/1s Off (Slow Flash): successfully connected to the router. Constantly On: successfully connected to the server. 100ms On/100ms Off (Fast Flash): fast network
	Communication with inverter	Constantly On: collector connected to the inverter. Light Off: communication with the inverter failed. 1s On/1s Off (Slow Flash): communication with the inverter successful.
	Operation status of recorder	Light off: abnormal operation 1s On/1s Off (Slow Flash): normal operation 100ms On/100ms Off (Fast Flash): factory reset

When the router is normally connected to the network, the normal operating status of the rod-type collector is as follows:

- (1) Successful connection status with the network: The NET indicator remains on after the collector is powered on.
- (2) Normal operation of the recorder: The READY indicator flashes.
- (3) Successful connection status with the inverter: The COM indicator remains on.

8.4 Handling of Abnormal Conditions

If the platform data is abnormal during the operation of the collector, please refer to the table below and carry out a simple troubleshooting based on the status of the indicator. If the indicators are not visible or if the problem persists, please contact our distributor. (Note: Wait for at least two minutes after startup before referring to the table.)

NET ● NET	COM ● COM	READY ● READY	READY Fault description	Fault causes	Solutions
Any status	OFF	Slow flash	Abnormal communication with inverter	<ol style="list-style-type: none"> 1. Loose or abnormal connection between the collector and inverter 2. Mismatch in communication rate between the inverter and collector 	<ol style="list-style-type: none"> 1. Check the connection between the collector and inverter, detach the collector and reinstall it. 2. Check the communication rate of the inverter to ensure it matches the collector's communication rate. 3. Press and hold the reset button for 5 seconds to restart the collector.
OFF	ON	Slow flash	Abnormal connection between the collector and router	<ol style="list-style-type: none"> 1. No network connection to the collector 2. Abnormal antenna 3. Weak WiFi signal strength 	<ol style="list-style-type: none"> 1. Check if the wireless network is configured. 2. Check whether the antenna is damaged or loose 3. Enhance the WiFi signal of the router, press and hold the reset button for 10 seconds to restart the collector and reconfigure the network.
Slow flash	ON	Slow flash	Normal connection between the collector and router, but abnormal connection between the collector and server	<ol style="list-style-type: none"> 1. Abnormal network of the router 2. Modification of the server point of the collector. 3. Network restriction, making it unable to connect to the server 	<ol style="list-style-type: none"> 1. Check if the router can access the network. 2. If the connection is restricted, check the router settings.

OFF	OFF	OFF	Abnormal power supply	<ol style="list-style-type: none"> 1. Loose or abnormal connection between the collector and inverter 2. Insufficient power of inverter 3. Abnormal collector 	<ol style="list-style-type: none"> 1. Normal connection between the collector and router, but abnormal connection between the collector and remote server
Fast flash	Any status	Any status	SMART LINK network status	Normal	<ol style="list-style-type: none"> 1. Automatically exits after 5 minutes. 2. Press and hold the reset button for 5 seconds to restart the collector.
Any status	Any status	Fast flash	Factory reset	Normal	<ol style="list-style-type: none"> 1. Automatically exits after 1 minute. 2. Press and hold the reset button for 5 seconds to restart the collector.

8.5 Operation Method of the Reset Button

8.5.1 Operation Method and Button Description for Reset Button

Button press	Status description	Indicator status
Short press for 1s	SMARTLINK fast networking	NET indicator flashes quickly every 100ms
Long press for 5s	Collector restart	All indicators immediately switch off
Long press for 10s	Collector reset	<ol style="list-style-type: none"> 1. All indicators switch off after 4s 2. READY indicator flashes quickly every 100ms



CAUTION

Do not remove the waterproof plug.



9 SOLARMAN Smart APP

9.1 Registration

To register your information on SOLARMAN Smart, please tap on "Register" to create your account.

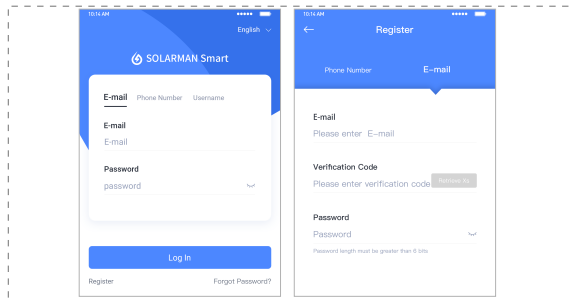

9.2 Create a Plant

Tap on "Add Now" to create. Please fill in the basic information and other details of the power plant here.

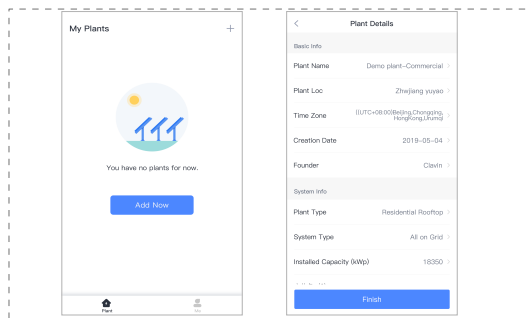

9.3 Add a Collector

Method 1: Manually enter the collector SN code.

Method 2: Tap on the icon on the right to scan and enter the SN code. You can find the SN code on the outer package and casing of the collector.

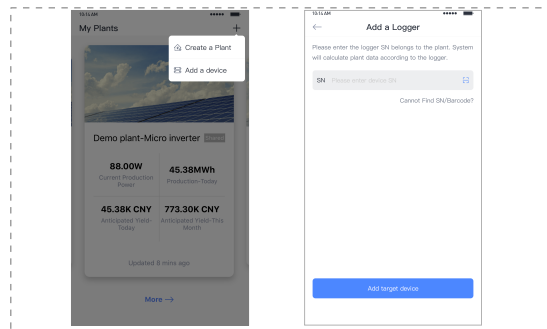

9.4 Network Configuration

After adding the collector, please configure the network to ensure the normal operation of the collector. Go to "Plant Details" - "Device List," find the device corresponding to the SN code, and then tap on "Networking".

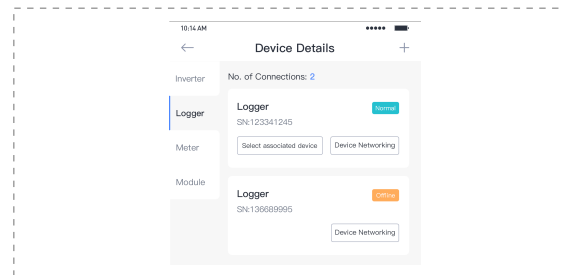

Step 1: Confirm Wi-Fi information

Please make sure that your phone is connected to the correct WIFI network and then tap on "Start".

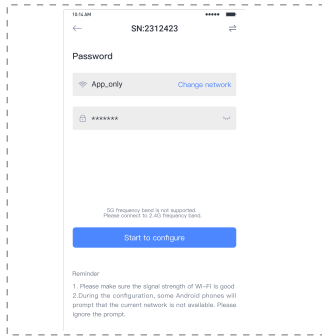

CAUTION
5G WIFI is not supported. Router names and passwords do not support special characters (e.g ., : , " = ").

Step 2: Connect to the AP Network, tap on "Go to connect" and find the correct "AP_XXXXX" network (XXXXX refers to the collector's SN code). If a password is required, you can find the corresponding password on the collector's casing. After connecting to the AP network, return to the SOLARMAN Smart APP.

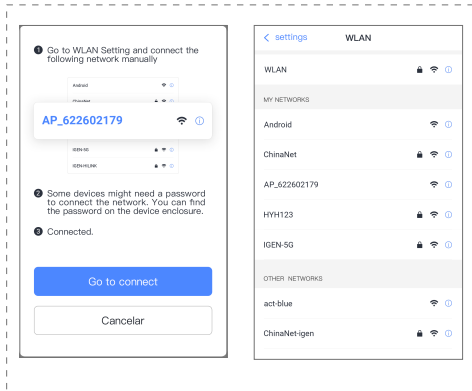

Step 3: Automatic configuration

Please wait for some time to complete the configuration. Then proceed to the next page. Tap on "Done" and check the plant data. (Usually, the data will be updated within 10 minutes).

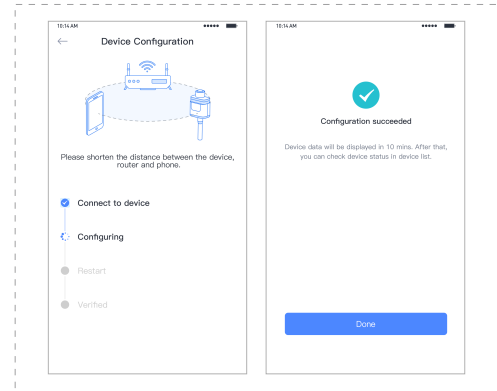

If the configuration fails, please check the following reasons and retry:

- (1) Make sure WLAN is turned on.
- (2) Ensure that Wi-Fi is working properly.
- (3) Verify that the wireless router is not implementing a blacklist or whitelist.
- (4) Remove special characters from the Wi-Fi network.
- (5) Shorten the distance between the phone and device.
- (6) Try connecting to a different Wi-Fi network.

10 Alarm and Fault Codes

10.1 Alarm Codes

S/N	Code	English Description
0	W00	Grid Volt Low
1	W01	Grid Volt High
2	W02	Grid Frequency Low
3	W03	Grid Frequency High
4	W04	Solar Loss
5	W05	Bat Loss
6	W06	Bat Under Volt
7	W07	Bat Volt Low
8	W08	Bat Volt High
9	W09	Overload Alarm
10	W10	GFCI Over
11	W11	L/N reverse connection
13	W13	Bat CapUnder
14	W14	Bms DisChg Over
15	W15	Bms Chg Over
16	W16	Bms Volt Over
17	W17	Bms Temp Over
18	W18	Bms Dis Temp Low
19	W19	Bms Volt Imbalance
20	W20	Bms Communicate Fault
21	W21	Bms Volt Under
22	W22	Bms Chg Temp Low
23	W23	Bms_VoltHigh
24	W24	Bms_TempHigh
25	W25	Bms_Updating

S/N	Code	English Description
26	W26	Bms_VersionErr
27	W27	Bms_UpdateFail
28	W28	CT Converse
29	W29	Cl0ck fail
30	W30	PV off
31	W31	System Reset

10.2 Fault Codes

S/N	Code	English Description
0	F00	Soft Time Out
1	F01	INV Volt Short
2	F02	GFCI Sensor Fault
3	F03	PV Voltage High Fault
4	F04	Bus Low Fault
5	F05	Bus High Fault
6	F06	Bus short Fault
7	F07	PV ISO Under Fault
8	F08	PV Input Short
9	F09	Op Relay Short
10	F10	INV Curr Over
11	F11	INV DC Over
12	F12	Ambient Over Temp
14	F14	Grid Relay Fault
15	F15	Chg Curr Over
16	F16	Chg Curr Over
17	F17	Current Sensor Fault

S/N	Code	English Description
18	F18	INV Abnormal
22	F22	Parallel Communicate Fault
23	F23	DCDC Sink Over Temp
25	F25	PV Sink Over Temp
26	F26	INV Sink Over Temp
27	F27	PV Boost Module Abnormal
28	F28	BUCK Module Abnormal
29	F29	Zero Ground Short Circuit
31	F31	SCI Fault
32	F32	Parallel Connection Line fault
33	F33	Carrier Synchronization Signal Fault
34	F34	Zero Crossing Synchronization Signal Fault
35	F35	ID Duplicate
36	F36	Loss Of Redundancy
37	F37	Parallel Machine Current Sharing Fault
38	F38	Insufficient Inverter Startup Capacity
39	F39	Fan Fault
40	F40	Over Load
41	F41	Parallel CAN communication failure

11 Fault Diagnosis and Handling

The inverter is user-friendly for maintenance. When you encounter the following problems, please refer to the following solutions. If the problem persists, please contact the local distributor. The table below lists some basic problems that may occur in actual operation and their corresponding basic solutions.

11.1 Fault Diagnosis Table

Type	Code	Solutions
Soft time out	F00	(1) Restart the machine and wait for it to return to normal; (2) If the fault is not resolved, contact the distributor.
Inverter short circuit	F01	(1) Cut off all power supplies, restart the machine and wait for it to return to normal. If the fault is eliminated, check if the load is short-circuited; (2) If the fault is not resolved, contact the distributor.
GFCI sensor error	F02	(1) Cut off all power supplies, restart the machine and wait for it to return to normal; (2) If the fault is not resolved, contact the distributor.
Low/high bus voltage	F04 F05	(1) Check if the input mode is correct; (2) Restart the machine and observe if it can return to normal; (3) If the fault is not resolved, contact the distributor.
Bus short circuit	F06	(1) Restart the machine and wait for it to return to normal; (2) If the fault is not resolved, contact the distributor.
Low PV insulation resistance	F07	(1) Check if the earth wire is well connected; (2) Check if the resistance of PV+ and PV- to ground is greater than 2MΩ; (3) If it is less than 2MΩ, check if the PV strings are grounded; if it is higher than 2MΩ and the fault is not resolved, please contact the local inverter distributor.

Type	Code	Solutions
PV input short circuit	F08	(1) Check if the input mode is correct; (2) Disconnect the PV input, restart the machine and observe if it can return to normal; (3) If the fault is not resolved, contact the distributor.
Relay fault	F09 F14	(1) Disconnect the PV input or AC input, restart the machine and observe if it can return to normal; (2) If the fault is not resolved, contact the distributor.
Inverter over current	F10	(1) Wait for five minutes for the inverter to automatically restart; (2) Check if the load meets specifications; (3) If the fault is not resolved, contact the distributor.
High DC component	F11	(1) Restart the inverter and observe if the machine can return to normal; (2) If the fault is not resolved, contact the distributor.
NTC/heat sink over-temperature	F12 F23 F25 F26	(1) After waiting for a few minutes for the inverter to cool down, restart the inverter and observe if it can return to normal. (2) Check if the ambient temperature exceeds the normal operating temperature range of the machine; (3) If the fault is not resolved, contact the distributor.
Battery discharging overcurrent	F15	(1) Wait for one minutes for the inverter to automatically restart; (2) Check if the load meets specifications; (3) If the fault is not resolved, contact the distributor.
Battery charging overcurrent	F16	(1) Check if the battery terminal is short-circuited; (2) Check if the charging current exceeds the set requirement; (3) If the fault is not resolved, contact the distributor.
Current sensor error	F17	(1) Restart the inverter and observe if the machine can return to normal; (2) If the fault is not resolved, contact the distributor.

Type	Code	Solutions
Abnormal inverter output	F18	(1) Please contact the distributor.
Fan fault	F39	(1) Restart the inverter and observe if the machine can return to normal; (2) If the fault is not resolved, contact the distributor.
Fan fault	F40	(1) The system load consistently exceeds the rated value; (2) If the fault is not resolved, contact the distributor.
Master-slave communication error	F31	(1) Restart the inverter and observe if the machine can return to normal; (2) If the fault is not resolved, contact the distributor.
Abnormal mains supply	W00 W01 W02 W03	(1) Check if the local voltage and frequency conform to the specifications of the machine; (2) If the voltage and frequency are within the allowable range, wait for 2 minutes for the inverter to return to normal. If the problem persists or the fault occurs repeatedly, contact local inverter customer service personnel; (3) If the voltage and frequency are outside the allowable range or unstable, contact the local power company.
PV disconnection	W04	(1) Not connected to PV; (2) Check power grid connection; (3) Check PV availability.
Battery disconnection	W05	(1) Battery disconnected; (2) Check if the battery terminal is short-circuited; (3) If the fault is not resolved, contact the distributor.
Battery undervoltage	W06	(1) Check battery availability; (2) If the fault is not resolved, contact the distributor.
Battery over voltage	W08	(1) Check if the battery used matches the settings; (2) If settings are correct, power off and restart; (3) If the fault is not resolved, contact the distributor.

Type	Code	Solutions
Leakage current error	W10	(1) Check if the PV string is directly or indirectly grounded; (2) Check if there is leakage current in the peripheral facilities of the machine; (3) If the fault persists, contact the distributor.
BMS alarm	W14-W27	(1) Please contact the distributor.
CT reverse connection	W28	(1) Perform CT self-inspection; (2) If the fault is not resolved, contact the distributor.
Clock initialization failure	W29	(1) Restart the inverter and observe if the machine can return to normal; (2) If the fault is not resolved, contact the distributor.

12 Product Specifications

Model	3600-24	3600-48	6000-48
PV terminal			
Maximum PV input voltage	500Vd.c.		
Rated voltage	240Vd.c.	360Vd.c.	
MPPT voltage range	120~450Vd.c.		
MPPT circuit numbers	1		
Maximum PV input current	18Ad.c.	22Ad.c.	
Maximum input power	4000W	6700W	
Isc PV	21Ad.c.	25Ad.c.	
Battery terminal			
Battery type	Lithium battery or lead-acid battery		
Rated voltage	24Vd.c.	48Vd.c.	
Maximum charging current	120Ad.c.	60Ad.c.	120Ad.c.
Maximum discharging power	3600W		6000W
On-grid terminal			
AC input power:	3600W		6000W
AC rated input:	220/230/240Va.c., 50/60Hz		
Max.AC input current:	15.7Aa.c		26Aa.c
Back-up terminal			
Rated voltage/frequency	220/230/240Vac, 50/60Hz		
Rated output power	3600W/3600VA	6000W/6000VA	
General parameters			
Operating temperature range	-10°C ~ 50°C		
Protection class	IP21		
Altitude	< 3000m		
Dimensions (D×W×H/mm)	134.0*427.5*460.8mm		
Net weight (kg)	11.5kg	11.6kg	13.2kg

Relative humidity	5%~95% (without condensation)
Display	LCD/APP
Communication interface	RS232/USB/Dry Contact; Optional:RS485/CAN/WIFI
Battery mode efficiency(peak)	93.5%
Function protection	Short circuit protection, grounding fault protection, overtemperature protection, overload protection, and surge protection

13 Routine Maintenance

13.1 Inspection Plan for Cables, Equipment and Terminals

(Every six months)

- Inspect if wire connections are loose.
- Inspect if the cables are aged/damaged.
- Inspect if the cable insulation tape peels off.
- Inspect if the cable terminal screws are loose or show signs of overheating.
- Inspect if the grounding connection is in good condition.
- Inspect if the battery system equipment fails or is damaged.
- Inspect if there is any abnormal noise from various parts of the inverter during inverter operation.
- Inspect if the battery voltage, battery temperature and other equipment parameters are normal during inverter operation.
- Inspect if cable connections are loose and if the cables are aged/damaged.
- Inspect if the management system of the system equipment, monitoring system, and related equipment fails or is damaged.
- Inspect if the equipment is well grounded and if the grounding resistance is less than 10 ohms.
- Inspect if the cable pulling tapes are intact.

13.2 Equipment Cleaning

(Carried out every three to six months, depending on the on-site environment and dust content)

Ensure that the ground is tidy and the passageway is clear; ensure that warning and guidance signs are clear and intact.

The equipment comes with a dust cleaning reminder function. When this function is triggered, please clean the dust promptly.

13.3 Cleaning and Maintenance of Dust Protection Kit

Each inverter has been fitted with a factory-provided dust protection kit. This kit can prevent inverter faults, enhancing the product's reliability in harsh environments.

Cleaning and maintenance

Step 1: First turn off all power sources of the machine and put it in a shutdown state.

Step 2: Remove the screws on the side of the inverter.

Step 3: Remove the dust protection kit, and take out the air filter foam as shown in the diagram below.

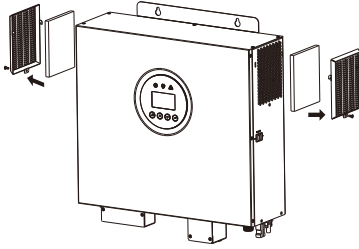

Step 4: Clean the air filter foam and the dust protection enclosure. After cleaning, reassemble the dust protection kit onto the inverter.

Step 5: After replacing the dust cover, you'll need to restart the machine to restore the default periodic dust removal setting. It will remind users to dust regularly after three months. If user want to extend the dust removal time, they can go to CLEAR DUST, choose ENABLE, and select either 3 months or 6 months for scheduled dust removal.

14 Quality Commitment

The manufacturer is responsible for the damage that occurs during normal use under the required environment during the warranty period.

For faults during the warranty period, the manufacturer will provide free spare parts to the agent/dealer.

Voucher

During the warranty period, the customer shall provide the product purchase invoice and detail the date of purchase. Additionally, the trademark on the product shall be intact and legible, otherwise the manufacturer reserves the right to refuse warranty claims.

Condition

Faulty products which have been replaced will be handled by the manufacturer.

Customers shall allow the manufacturer or its distributors a reasonable amount of time to repair the faulty equipment.

Disclaimer

In the following circumstances, the manufacturer reserves the right to refuse warranty claims:

- The free warranty period for the entire machine/component has expired.
- The equipment is damaged during transportation.
- The equipment is subject to incorrect installation, reinstallation, or operation.
- The equipment is operated in harsh environments as described in the Manual.
- Faults or damages are caused by the installation, maintenance, modification, or disassembly carried out by personnel of the service provider, non-manufacturer, or their authorized partners.
- Faults or damages are caused by abnormal usage or non-compliance with the manufacturer's standards.

Components or software

- The scope of installation and use exceeds the provisions of relevant international standards.
- Damages are caused by unexpected natural factors.

For the faulty products under any of the above circumstances, paid maintenance services can be provided based on the manufacturer's assessment if the customer requests maintenance.

15 Limitation of Liability

No direct or indirect liability will be assumed for product damage or property loss caused by the following circumstances:

- Product modification, design alteration, or component replacement without manufacturer's authorization;
- Change and repair of seals, or removal of serial numbers or by non-manufacturer technicians;
- Inverter design and installation not conforming to standards and regulations.
- Failure to comply with local safety regulations;
- Damage during transportation (including paint scratches caused by friction inside the package during transport). In such cases, claims shall be filed immediately with the shipping company or insurance company after the container/package is unloaded and the damage is confirmed;
- Non-compliance with any/all user manuals, installation guides, and maintenance regulations;
- Improper use or misuse of equipment;
- Inadequate ventilation of equipment;
- Failure to conduct maintenance according to standard procedures;
- Force majeure events (storms, lightning, over voltage, fires, etc.);
- Any damage caused by external factors.



Jumeirah Bay X2 Tower, Office # 3505
Jumeirah Lakes Towers, Dubai
United Arab Emirates

Tel:+971 4 422
Fax:+971 4 422 56 54
email: support@nastech.ae